

James Patrick Partnership Ltd. HD Guard Rail System

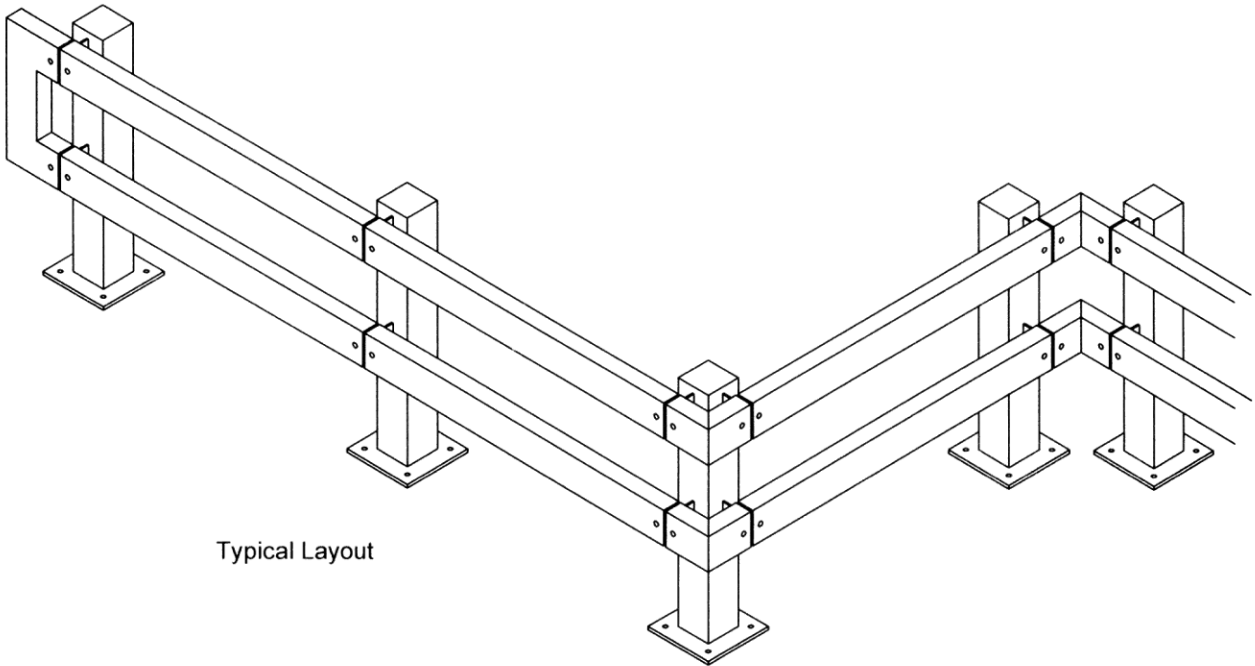

Typical Layout

The HD Guard Rail System is a high performance, flexible and modular product intended for use in the warehouse / workshop environment to protect pedestrian and goods storage areas and fixed equipment such as pallet racking and shelving. Designed primarily for use in areas where low speed fork trucks operate, it is also flexible enough for use in a host of other situations. Fabricated from structural steel sections and finished using the hot dip galvanised process, the product will maintain a top quality finish for many years. All fixings are finished using the same process and all ground fixings are high performance resin anchors.

On the reverse are details of the component parts of the system, so simply set out your plan using the example below, select the components required and we can then provide a competitive cost to meet your requirements.

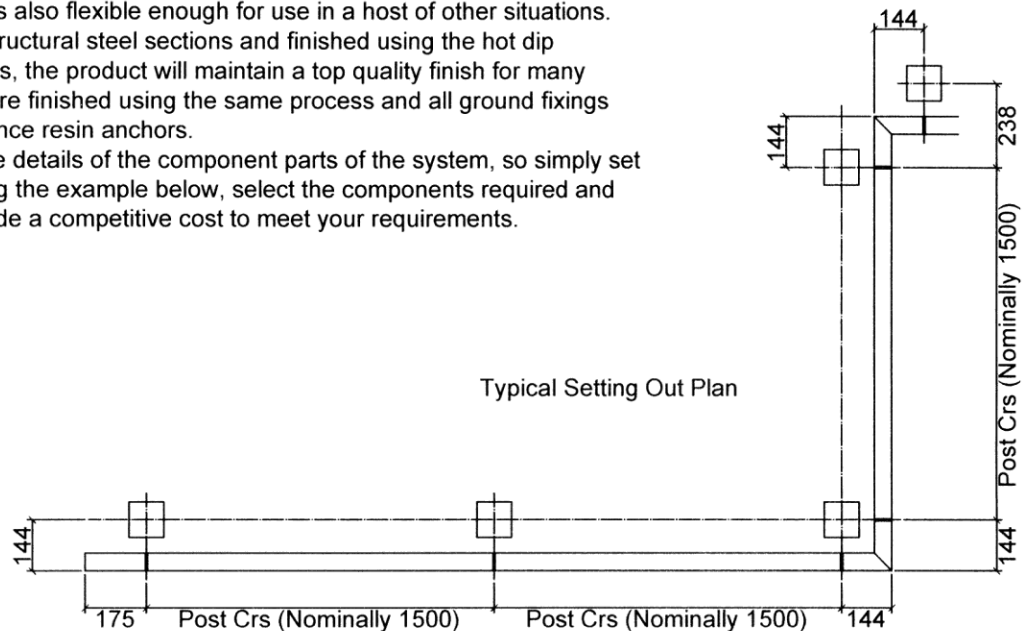

Typical Setting Out Plan

(See reverse for component details)

James Patrick Partnership Ltd.
6 Hillcrest
Beighton Road
Acle
Norfolk NR13 3DA

Registered in England No. 5101331
VAT No. 803 0724 70

Tel. 01493 750737
Fax. 01493 754170
email. info@jpp.uk.com
url. www.jpp.uk.com

James Patrick Partnership Ltd. HD Guard Rail System Components

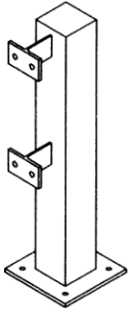

Standard Post 700mm High
100 x 100 x 4 shs post
200 x 200 x 10 baseplate
2 Tee section brackets
Weight 12.92 kgs each



Standard End Closer
1 required per end
100 x 50 x 10 pfc section
Weight 5.55 kgs each



External Corner Closer
2 required per corner
100 x 50 10 pfc section
Weight 4.69 kgs per pair

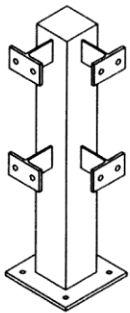

Corner Post 700mm High
100 x 100 x 4 shs post
200 x 200 x 10 baseplate
4 Tee section brackets
Weight 14.06 kgs each



Internal Corner Closer
2 required per corner
100 x 50 x 10 pfc section
Weight 4.69 kgs per pair



Post Levelling Packs
100 x 100 x 3 galvanised plate
25 per pack
Weight 5.9 kgs per 25

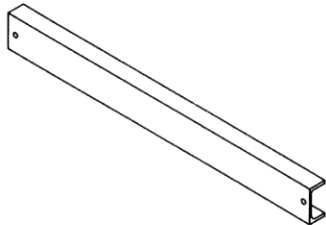

Standard Rail to suit 1500mm post centres
(Order actual post centres required)
100 x 50 x 10 pfc section
Weight 15.3 kgs each @ 1500mm long

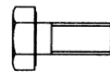

Standard Post Fixing Pack
Containing:
4 M16 x 30 galv bolts with nuts and washers
4 M12 x 160 galv resin anchor studs with nuts and washers
Weight 1.01 kgs per pack

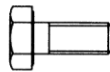

Corner Post Fixing Pack
Containing:
8 M16 x 30 galv bolts with nuts and washers
4 M12 x 160 galv resin anchor studs with nuts and washers
Weight 1.48 kgs per pack

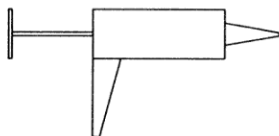

J-Fix Concrete Resin Applicator
& J-Fix Blow Out Pump



J-Fix Concrete Resin Tube
Approx 1 tube per 10 posts
Weight 0.79 kgs each

James Patrick Partnership Ltd.
6 Hillcrest
Beighton Road
Acle
Norfolk NR13 3DA

Registered in England No. 5101331
VAT No. 803 0724 70

Tel. 01493 750737
Fax. 01493 754170
email. info@jpp.uk.com
url. www.jpp.uk.com